

Data Sheet



Article number: 04H081901500350V2

Description: Stabilus IndustryLine stainless steel gas spring size 08/19
350N length 345mm, stroke 150mm Type 04H0819350

Measures

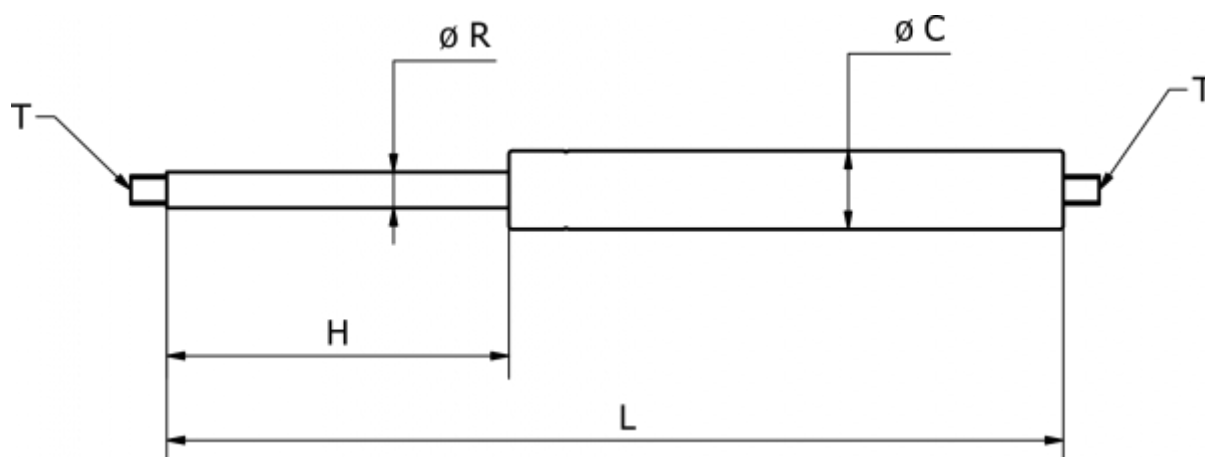

C = 19

H = 150

L = 345

R = 8

T = M8 x 10